



**COMPLETE STEEL &
FIBERGLASS EXTERIOR
DOOR OFFERING**

We are **America's doormaker**

VIEW OUR ENTIRE OFFERING AT TAYLORDOOR.COM

MICHIGAN MADE SINCE 1946



Our beautiful state is populated with industrious, dedicated and talented people. Passion, hard work and respect – it's the culture of our workplace. Our products are built with pride and confidence, giving you the satisfaction of buying a high-quality, reliable product.

We are **America's** doormaker.

CONTENTS

4	PROJECT TYPES	36	CUSTOM CAPABILITIES
6	STEEL ENTRANCE DOORS	38	TECHNICAL TOOLS
22	FIBERGLASS ENTRANCE DOORS	40	HURRICANE & WINDLOAD APPROVALS
30	FRAME SYSTEMS	42	ORDERING YOUR DOOR

THE TAYLOR

ADVANTAGE

We are dedicated to providing you with long lasting, quality products, leading-edge product innovation, and exceptional customer service.

SELECTION

- Wood-edge
- Steel-edge
- Fiberglass
- Available in a variety of textures and styles

COMPLIANCE

- Fire rated
- Texas Dept. of Insurance (TDI)
- ENERGY STAR
- Florida FBC
- ADA
- STC
- NFRC

CAPABILITY

- Custom width and heights
- Special face and edge preps
- Slabs or pre-hung
- Steel or wood frame
- Hinge and bore locations to your specs

AVAILABILITY

- No order minimums
- Stock sizes and profiles ship in 10 days or less
- Additional sizes & profiles available (with extended lead time)



PROJECT TYPES

At Taylor Entrance Systems™, we use only top-quality materials to help bring your vision to life. We have a wide range of styles and textures to meet your architectural style or design needs. Taylor offers the perfect door solutions for multi-family and light commercial projects. We can provide you what you need, when you need it.





LET TAYLOR ENTRANCE SYSTEMS™ be a part of your next project

- ✓ Residential Living
- ✓ Office Buildings
- ✓ Hotel and Hospitality
- ✓ Multi-family
- ✓ Student Housing
- ✓ Assisted Living
- ✓ Hospitals and Clinics
- ✓ Places of Worship
- ✓ Financial Institutions
- ✓ Warehouses
- ✓ Manufacturing Facilities
- and more...



Shown: Cambridge Smooth Steel
8/0 6-Panel in TaylorKote Carbon

STEEL

DOOR COLLECTIONS



8
CAMBRIDGE
SMOOTH STEEL



COMING SOON

12
WESTGUARD
20-GAUGE STEEL



14
TRUGRAIN
PRE-FINISHED STEEL



16
NORWOOD
STAINABLE STEEL



18
TRUKOTE
PRE-FINISHED STEEL



20
EDGEWOOD
WOOD-EDGE STEEL

BUILT IN ADVANTAGES

Quality entrance systems start with quality components. Our steel door collections are made-to-order and built by talented craftspeople in West Branch, Michigan. We source American made steel, guaranteeing quality and performance for years to come.

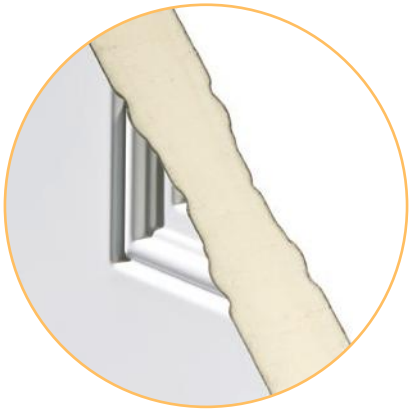

POLYURETHANE FOAM CORE

Polyurethane foam enhances sound proofing and has insulation properties that are at least 4 times greater than wood doors. The foam also acts as a bonding agent, locking all internal components in place for enhanced durability.



GRADE 40
SECURITY
RATING

FULL STEEL EDGE PERIMETER

Our steel-edge doors receive the highest rating possible in the industry's toughest forced entry test. A steel-edge door must withstand the force beyond 7 hits from a 100 pound test weight to achieve a Grade 40 rating.



REINFORCED LOCK BLOCK AREA

Steel doors are constructed with a composite lock block to provide secure mounting of door hardware and better structural integrity. The reinforced lock area offers more screw-holding power than wood.



ADJUSTABLE HINGE PLATE

This one-of-a-kind hinge plate is built into our slab, allowing the door to be easily adjusted in any direction without removing it from the frame. Adjustments can be made with a screwdriver at any time.

CAMBRIDGE

SMOOTH STEEL COLLECTION



Shown: Flush 4-Groove in Custom Color

The Cambridge Collection is designed for strength, security and durability. This premium collection resists cracking, splitting, warping, twisting, rotting, and corrosion. Choose from our largest selection of door styles that range from traditional to modern to complement nearly any project type. Now Available in TaylorKote Commercial Finish (see page 30 for details).

- Constructed out of 22- or 24-gauge hot-dip galvanized steel
- Full steel-edge perimeter grants an industry-leading Grade 40 Security Rating
- 20-gauge hinge reinforcements
- Polyurethane foam inner core provides superior insulation
- 90-minute fire rated
- Equipped with the Adjustable Hinge Plate System (*optional*)
- Baked-on polyester primer accepts exterior grade latex paint
- Limited Lifetime Warranty on 22-gauge steel, 10-Year Warranty on 24-gauge steel
- Available prehung, KD, or slab only (*wood or steel jambs*)

AVAILABILITY (22- AND 24-GAUGE STEEL)

FLUSH ★

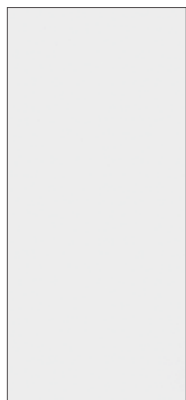

△90 ru

H 6'8" 7'0" 8'0"
W 2'0" 2'4" 2'6"
2'8" 2'10" 3'0"

1-PANEL HD



ADA △90 ru

H 6'8" 7'0"
W 2'8" 2'10" 3'0"

2-PANEL HD ★



ADA △90 ru

H 6'8" 7'0" 8'0"
W 2'8" 2'10" 3'0"

2-PANEL HD
ARCH TOP ★

△90 ru

H 6'8"
W 2'8" 2'10" 3'0"

2-PANEL HD
ARCH TOP PLANK

△90 ru

H 6'8"
W 2'8" 2'10" 3'0"

3/4 2-PANEL HD



△90

H 6'8"
W 2'8" 2'10" 3'0"

2-PANEL
HD COTTAGE

△90 ru

H 6'8"
W 2'8" 2'10" 3'0"

3-PANEL HD ★



△90 ru

H 6'8"
W 2'8" 2'10" 3'0"

3-PANEL HD
CRAFTSMAN

△90 ru

H 6'8"
W 2'8" 2'10" 3'0"

CROSSBUCK

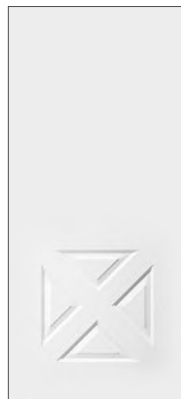

△90 ru

H 6'8" 7'0"
W 2'6" 2'8" 2'10" 3'0"

4-PANEL
BLANK TOP ★

ADA △90 ru

H 6'8" 7'0"
W 2'6" 2'8" 2'10" 3'0"

TRUE 4-PANEL ★



ADA △90 ru

H 6'8"
W 2'8" 2'10" 3'0"

5-PANEL



△90

H 6'8" 7'0"
W 2'8" 2'10" 3'0"

6-PANEL STD ★



△90 ru

H 6'8" 7'0" 8'0"
W 2'6" 2'8" 2'10" 3'0"

6-PANEL HD ★



ADA △90 ru

H 6'8" 7'0"
W 2'6" 2'8" 2'10" 3'0"

8-PANEL ★



ADA △90 ru

H 6'8" 7'0"
W 2'8" 2'10" 3'0"

9-PANEL



△90 ru

H 6'8" 7'0"
W 2'8" 2'10" 3'0"

2-PANEL
BLANK TOP ★

△90

H 8'0"
W 2'8" 2'10" 3'0"

AVAILABILITY (22-GAUGE STEEL ONLY)

1-PANEL SHAKER



ADA ♠**90**
 H 6'8" 7'0" 8'0"
 W 2'8" 2'10" 3'0"

2-PANEL SHAKER



ADA ♠**90**
 H 6'8" 7'0"
 W 2'8" 2'10" 3'0"

3-PANEL SHAKER



ADA ♠**90**
 H 6'8" 7'0"
 W 2'8" 2'10" 3'0"



Close up detail of the 3-Panel Shaker embossment

4-PANEL SHAKER



♠**90**
 H 6'8"
 W 2'8" 2'10" 3'0"

3-PANEL CONTEMPORARY



♠**90**
 H 6'8"
 W 2'8" 2'10" 3'0"

FLUSH 4-GROOVE



♠**90**
 H 6'8"
 W 2'8" 2'10" 3'0"

FLUSH 4-GROOVE CONTEMPORARY



♠**90**
 H 6'8"
 W 2'8" 2'10" 3'0"

FLUSH 5-GROOVE



♠**90**
 H 6'8"
 W 2'8" 2'10" 3'0"



Shown: 4-Panel Shaker in TaylorKote Carbon



Shown: 3/4 2-Panel in TaylorKote Slate



Shown in TaylorKote Pebble

90 1-PANEL SHAKER

H 8'0"

W 2'8" 2'10" 3'0"



Shown in TaylorKote Sand

90 6-PANEL HORIZONTAL

H 8'0"

W 2'8" 2'10" 3'0"

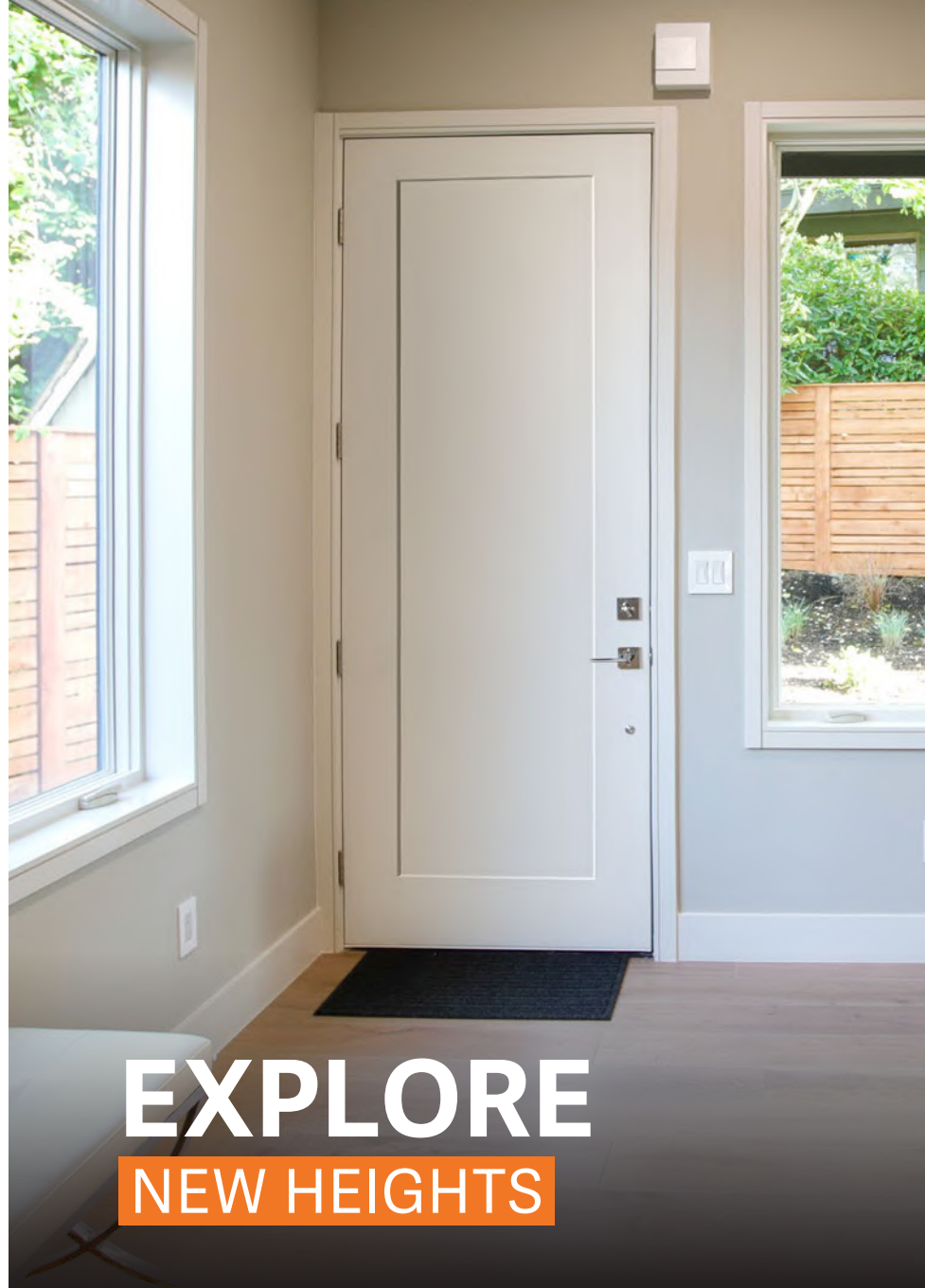

Shown: 8/0 1-Panel Shaker in TaylorKote Classic White

EXPLORE NEW HEIGHTS

NEW 8' DOOR STYLES

The Cambridge Smooth Steel Collection offers a variety of door styles designed to complement nearly any architectural style. Today's trends are demanding larger than life openings with understated details. The simple and clean design of the 1-Panel Flat Shaker and 6-Panel Horizontal make them the perfect, modern solution for large openings.

★ NEW PRE-FINISH CAPABILITIES! SEE PAGE 30

COMING SOON

AVAILABLE 2021











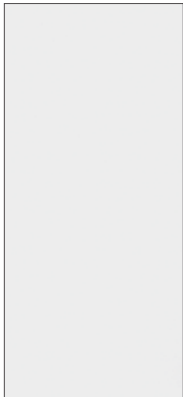

WESTGUARD

20-GAUGE STEEL COLLECTION

Our toughest door collection to date. The WestGuard Collection is constructed out of durable, 20-gauge, hot-dip galvanized steel and is ideal for commercial jobs.

- Constructed out of 20-gauge hot-dip galvanized steel that resists corrosion
- Full steel-edge perimeter grants an industry-leading Grade 40 Security Rating
- 20-gauge hinge reinforcements
- Polyurethane foam inner core provides superior insulation
- 90-minute fire rated
- Equipped with the Adjustable Hinge Plate System (*optional*)
- Baked-on polyester primer accepts exterior grade latex paint
- Limited Lifetime Warranty
- Available prehung, KD, or slab only (*wood or steel jambs*)

AVAILABILITY (20-GAUGE STEEL ONLY, COMING SOON)

<p>FLUSH *</p>  <p>ADA ♠90</p> <p>H 6'8" 7'0" 8'0" W 2'0" 2'4" 2'6" 2'8" 2'10" 3'0" 4'0"</p>	<p>2-PANEL HD</p>  <p>ADA ♠90</p> <p>H 6'8" 7'0" 8'0" W 2'8" 2'10" 3'0"</p>	<p>2-PANEL HD ARCH TOP *</p>  <p>♠90</p> <p>H 6'8" W 2'8" 2'10" 3'0"</p>	<p>4-PANEL BLANK TOP *</p>  <p>ADA ♠90</p> <p>H 6'8" 7'0" W 2'6" 2'8" 2'10" 3'0"</p>	<p>TRUE 4-PANEL *</p>  <p>ADA ♠90</p> <p>H 6'8" W 2'8" 2'10" 3'0"</p>	<p>6-PANEL HD</p>  <p>ADA ♠90</p> <p>H 6'8" 7'0" W 2'6" 2'8" 2'10" 3'0"</p>
<p>1-PANEL SHAKER</p>  <p>ADA ♠90</p> <p>H 6'8" 7'0" 8'0" W 2'8" 2'10" 3'0"</p>	<p>2-PANEL SHAKER</p>  <p>ADA ♠90</p> <p>H 6'8" 7'0" W 2'8" 2'10" 3'0"</p>	<p>3-PANEL SHAKER</p>  <p>ADA ♠90</p> <p>H 6'8" 7'0" W 2'8" 2'10" 3'0"</p>	<p>5-PANEL</p>  <p>♠90</p> <p>H 6'8" 7'0" 8'0" W 2'8" 2'10" 3'0"</p> <p><small>* 8'0" height available in 6-panel embossment</small></p>		

OPEN WIDER

Wide openings allow for small equipment, motorcycles, lawn mowers and other large items to pass through without requiring an overhead or double door.

The 4/0 wide by 6/8 high, 20-gauge steel door, is ideal for agricultural buildings, yard barns, garage service entrances and ADA applications.



TRUGRAIN™

PRE-FINISHED STEEL COLLECTION



Shown: 2-Panel Shaker in Walnut

Combine the look of wood with the strength of steel. The Trugrain™ Collection is pre-finished with a 3-step, high-quality polyester paint system that includes a color base coat, woodgrain ink pattern, and a durable, scratch-resistant topcoat. This collection is ideal for commercial and multi-family use with ADA embossment availability.

- Scratch-resistant top coat
- No finishing or maintenance required
- Constructed out of 22-gauge hot-dip galvanized steel that resists corrosion
- Full steel-edge perimeter grants an industry-leading Grade 40 Security Rating
- 20-gauge hinge reinforcements
- Polyurethane foam inner core provides superior insulation
- 90-minute fire rated
- Equipped with the Adjustable Hinge Plate System (*optional*)
- 10-Year Limited Warranty
- Available prehung, KD, or slab only (*wood or steel jambs*)

AVAILABILITY (22-GAUGE STEEL ONLY)

All embossments are available in Holland, Rockport, Ludington, and Brimley finish

FLUSH ★

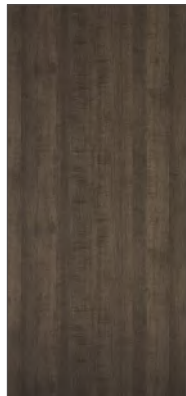

ru
 H 6'8" 7'0" 8'0"
 W 2'8" 2'10" 3'0"

1-PANEL SHAKER



ADA ru
 H 6'8" 7'0" 8'0"
 W 2'8" 2'10" 3'0"

2-PANEL SHAKER

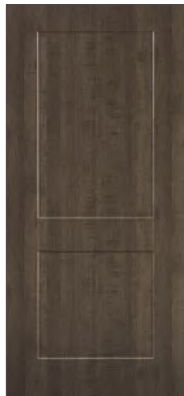

ADA ru
 H 6'8" 7'0"
 W 2'8" 2'10" 3'0"



Close up detail of the 2-Panel HD embossment

3-PANEL SHAKER

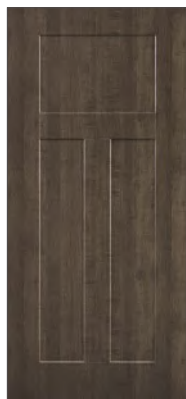

ADA ru
 H 6'8" 7'0"
 W 2'8" 2'10" 3'0"

2-PANEL HD ★



ADA ru
 H 6'8" 7'0" 8'0"
 W 2'8" 2'10" 3'0"

6-PANEL HD* ★



ADA ru
 H 6'8" 7'0" 8'0"
 W 2'8" 2'10" 3'0"

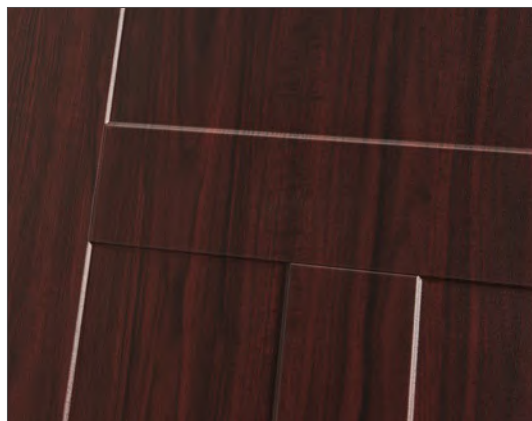

Close up detail of the 3-Panel Shaker embossment

* 8'0" height only available in standard embossment

4 UNIQUE FINISH OPTIONS

Colors shown are as accurate as printing technologies allow.

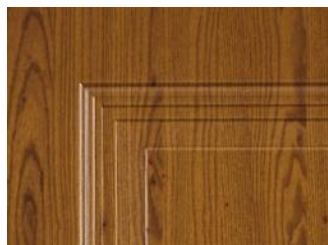

HOLLAND
 (Oak Grain)



BRIMLEY
 (Walnut Grain)



ROCKPORT
 (Oak Grain)

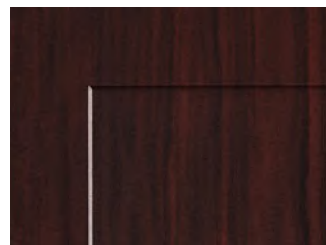

LUDINGTON
 (Cherry Grain)

NORWOOD

STAINABLE STEEL COLLECTION



Shown: 3-Panel Craftsman

Stainable steel entrance doors mimic the warmth and beauty of wood with the features and benefits of steel. These steel doors have a deeply embossed Oak wood grain surface. A special beige primer is applied that permanently bonds to the steel and accepts stain. Applying stain enhances the texture of the steel for an authentic woodgrain appearance.

- Constructed out of 22-gauge hot-dip galvanized steel that resists corrosion
- Full steel-edge perimeter grants an industry-leading Grade 40 Security Rating
- 20-gauge hinge reinforcements
- Polyurethane foam inner core provides superior insulation
- 90-minute fire rated
- Equipped with the Adjustable Hinge Plate System (*optional*)
- Special beige primer allows for staining (*stained finish is shown*)
- Limited Lifetime Warranty
- Available prehung, KD, or slab only (*wood or steel jamba*s)

AVAILABILITY (22-GAUGE STEEL ONLY)

FLUSH ★



♠90 ru
 H 6'8" 7'0" 8'0"
 W 2'0" 2'4" 2'6"
 2'8" 2'10" 3'0"

1-PANEL HD



ADA ♠90 ru
 H 6'8"
 W 2'8" 2'10" 3'0"

2-PANEL HD ★



ADA ♠90 ru
 H 6'8" 7'0" 8'0"
 W 2'8" 2'10" 3'0"

2-PANEL HD ARCH TOP ★



♠90 ru
 H 6'8"
 W 2'8" 2'10" 3'0"

2-PANEL HD ARCH TOP PLANK



♠90 ru
 H 6'8"
 W 2'8" 2'10" 3'0"

2-PANEL HD COTTAGE



♠90 ru
 H 6'8"
 W 2'8" 2'10" 3'0"

3-PANEL HD ★



♠90 ru
 H 6'8" 7'0"
 W 2'8" 2'10" 3'0"

3-PANEL HD CRAFTSMAN

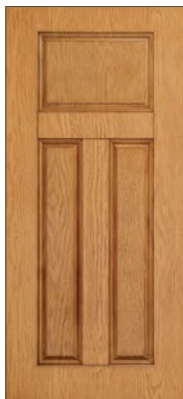

♠90 ru
 H 6'8" 7'0"
 W 2'8" 2'10" 3'0"

CROSSBUCK



♠90 ru
 H 6'8"
 W 2'8" 2'10" 3'0"

4-PANEL BLANK TOP ★



ADA ♠90 ru #
 H 6'8" 7'0"
 W 2'6" 2'8" 2'10" 3'0"

TRUE 4-PANEL ★



ADA ♠90 ru
 H 6'8" 7'0"
 W 2'6" 2'8" 2'10" 3'0"

6-PANEL ★



ADA ♠90 ru #
 H 6'8" 7'0" 8'
 W 2'6" 2'8" 2'10" 3'0"



Close up detail of stained steel

8-PANEL ★



ADA ♠90 ru
 H 6'8" 7'0"
 W 2'8" 2'10" 3'0"

9-PANEL



♠90 ru #
 H 6'8" 7'0"
 W 2'8" 2'10" 3'0"

2-PANEL BLANK TOP ★



♠90
 H 8'0"
 W 2'6" 2'8" 2'10" 3'0"



The Trukote Collection is pre-finished with a white polyester paint that requires no additional finishing. This collection is ideal for projects that require a ready-to-install option or that are looking to achieve a clean, classic aesthetic.

- Made from 24-gauge hot-dip galvanized steel that resists corrosion
- Full steel-edge perimeter grants an industry-leading Grade 40 Security Rating
- 20-gauge hinge reinforcements
- Polyurethane foam inner core provides superior insulation
- 90-minute fire rated
- Equipped with the Adjustable Hinge Plate System (*optional*)
- No finishing or maintenance required
- 10-Year Limited Lifetime Warranty
- Available prehung, KD, or slab only (*wood or steel jambs*)

TRUKOTE

PRE-FINISHED STEEL COLLECTION

AVAILABILITY (24-GAUGE STEEL ONLY)

FLUSH

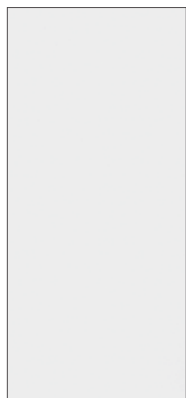

☆90
 H 6'8" 7'0" 8'0"
 W 2'0" 2'4" 2'6"
 2'8" 2'10" 3'0"

1-PANEL HD



ADA ☆90
 H 6'8" 7'0"
 W 2'8" 2'10" 3'0"

2-PANEL HD



ADA ☆90
 H 6'8" 7'0" 8'0"
 W 2'8" 2'10" 3'0"

2-PANEL HD ARCH TOP



☆90
 H 6'8" 7'0"
 W 2'8" 2'10" 3'0"

2-PANEL HD ARCH TOP PLANK



☆90
 H 6'8" 7'0"
 W 2'8" 2'10" 3'0"

2-PANEL HD COTTAGE



☆90
 H 6'8" 7'0"
 W 2'8" 2'10" 3'0"

3-PANEL HD CRAFTSMAN



☆90
 H 6'8" 7'0"
 W 2'8" 2'10" 3'0"

TRUE 4-PANEL



ADA ☆90
 H 6'8" 7'0"
 W 2'8" 2'10" 3'0"

6-PANEL STD



☆90
 H 8'0"
 W 2'8" 2'10" 3'0"

6-PANEL HD



ADA ☆90
 H 6'8" 7'0"
 W 2'8" 2'10" 3'0"



Shown: 6-Panel HD with lite cut out

EDGEWOOD®

WOOD-EDGE STEEL COLLECTION



Shown: 2-Panel HD

Edgewood® is a steel entrance door system that features a wood stile and rail system, along with a composite bottom rail that guards against both rot and insects. This collection is constructed out of 25-gauge steel with a 10° face sheet bend and a white primer finish.

- Constructed out of 25-gauge hot-dip galvanized steel that resists corrosion
- Polyurethane foam inner core provides superior insulation
- 20-minute fire rated
- 1-1/4" solid wood stile and rail system, along with a composite bottom rail that guards against both rot and insects
- White primer finish on both sides
- Available prehung, KD, or slab only (wood or steel jambs)

AVAILABILITY (25-GAUGE STEEL ONLY)

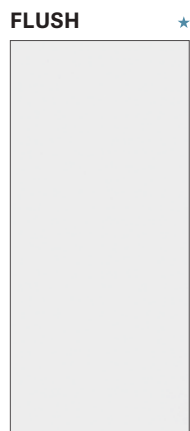

♠20
 H 6'8"
 W 2'0" 2'4" 2'6"
 2'8" 2'10" 3'0"



ADA ♠20
 H 6'8"
 W 2'8" 2'10" 3'0"

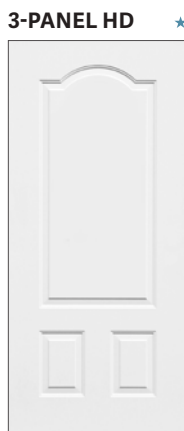

♠20
 H 6'8"
 W 2'8" 2'10" 3'0"



♠20
 H 6'8"
 W 2'6" 2'8" 2'10" 3'0"



ADA ♠20
 H 6'8"
 W 2'6" 2'8" 2'10" 3'0"



ADA ♠20
 H 6'8"
 W 2'8" 2'10" 3'0"



♠20
 H 6'8"
 W 2'6" 2'8" 2'10" 3'0"



ADA ♠20
 H 6'8"
 W 2'8" 2'10" 3'0"



ADA ♠20
 H 6'8"
 W 2'8" 2'10" 3'0"



♠20
 H 6'8"
 W 2'8" 2'10" 3'0"



1-1/4" solid wood stiles



Composite bottom rail



Shown: Timbergrain Fir 1-Panel Shaker with 3.5" wide Simulated Divided Lite Bars

FIBERGLASS

DOOR COLLECTIONS



24
GRAND MARAIS

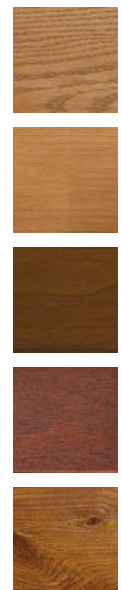

26
TIMBERGRAIN

BUILT IN ADVANTAGES

Fiberglass entrance doors are the perfect complement to nearly any project that desires the warmth and comfort of wood. They add depth and dimension, while also being low maintenance and energy-efficient. Our fiberglass door collections are engineered for durability and longevity and are available in a variety of textures.



DURABLE CONSTRUCTION

Our fiberglass door collections are made from high-impact, compression molded skins that are designed not to crack, splinter, warp, rot, or delaminate and feature composite top and bottom rails that protect against water infiltration.



WARMTH OF WOOD

Fiberglass skins are compression molded with high quality, debossed wood grain patterns and architecturally correct rails and stiles. The skins easily accept paint or stain and replicate the appearance of real wood doors.



POLYURETHANE FOAM CORE

Fully insulated with an inner core of polyurethane foam that acts both as a bonding agent and also provides superior insulation. Polyurethane foam enhances sound proofing and has insulation properties that are at least 4 times greater than wood doors.



ADJUSTABLE HINGE PLATE*

This one-of-a-kind plate is built into our slab, allowing the door to be easily adjusted in any direction without removing it from the frame. Adjustments can be made with a screwdriver at any time.

*Unavailable on Grand Marais Fiberglass Collection

GRAND MARAIS

FIBERGLASS COLLECTION



Shown: Direct Glazed One Lite in Fir Grain texture

The Grand Marais Fiberglass Collection is designed with energy and thermal performance in mind, while also providing depth and dimension to any entryway. This collection is available in three finishes: Oak Grain, Fir Grain, or White Smooth.

- Unaffected by moisture and humidity
- Full-length composite stiles and rails with HydroShield provide a 6-sided protection against water infiltration, mold, and insects
- Made from high-impact fiberglass reinforced skins
- Surface easily accepts paint and stain, while also being easy to clean
- Polyurethane foam inner core provides superior insulation
- 20-minute fire rated (select door styles)
- 25-year limited warranty on Timberline Smooth, limited lifetime warranty on Timberline Textured
- Available prehung, KD, or slab only (wood or steel jambs)

AVAILABLE TEXTURES:



OAK GRAIN



FIR GRAIN

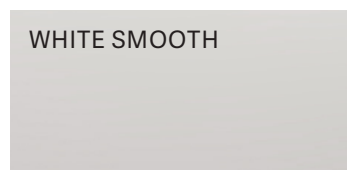

WHITE SMOOTH

AVAILABILITY

1-PANEL SHAKER

Fir Grain or Smooth



ADA RU 3'0" x 6'8" Fir only

H 6'8"
W 2'8" 2'10" 3'0"

2-PANEL SHAKER

Fir Grain or Smooth



ADA RU 3'0" x 6'8" only

H 6'8"
W 2'8" 3'0"

3-PANEL SHAKER

Fir Grain or Smooth ★



ADA RU 3'0" x 6'8" only

H 6'8" 8'0"
W 3'0"

5-PANEL SHAKER

Fir Grain or Smooth



ADA RU 3'0" x 6'8" Smooth only

H 6'8"
W 3'0"

DIRECT GLAZED ONE LITE

Smooth or Fir Grain



ADA RU 20

H 6'8" 8'0"
W 3'0"

2-PANEL ★

Smooth Only



ADA RU 20

H 6'8" 7'0" 8'0"
W 3'0"

FLUSH ★

Oak Grain or Smooth



ADA RU 3'0" x 6'8" only

H 6'8" 7'0" 8'0"
W 2'6" 2'8" 3'0"

3/4 4-PANEL ★

Oak Grain or Smooth



H 6'8"
W 3'0"

4-PANEL BLANK TOP ★

Oak Grain or Smooth



H 6'8"
W 2'8" 3'0"

6-PANEL

Oak Grain or Smooth



ADA RU 3'0" width only

H 6'8" 7'0" 8'0"
W 2'8" 3'0"

DIRECT GLAZED ONE LITE

Low-E glass is built directly into this door panel, eliminating the need for a glass frame and creating a seamless appearance. This door style is constructed with a composite stile cap and bottom rail, full length laminated veneer lumber stiles, leak protection glazing tape, and an integrally molded glass stop. Available in White Smooth or Fir Grain textures.



Shown: Direct Glazed One Lite in White Smooth texture

TIMBERGRAIN

FIBERGLASS COLLECTION



Shown: 2-Panel Arch Top in Knotty Alder texture

Timbergrain fiberglass entrance doors are constructed of high resolution, grained, fiberglass skins. They offer the warmth of wood and its natural variation of grain characteristics in Cherry, Mahogany, Fir, Oak, and Knotty Alder.

- 4" full-length engineered hinge and lock stiles
- Square 1/2" hardwood capped edges are rot-resistant
- 1" composite top and bottom rail protects against water infiltration, mold, and insects
- Equipped with the Adjustable Hinge Plate System (*optional*)
- Polyurethane foam inner core provides superior insulation
- 1/10" thick high-impact molded fiberglass reinforced skins
- Limited Lifetime Warranty
- Available prehung, KD, or slab only (*wood or steel jambs*)

AVAILABLE TEXTURES:

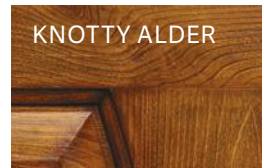
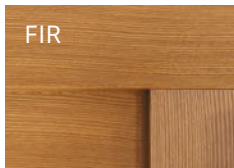

AVAILABILITY

FLUSH

Cherry ★

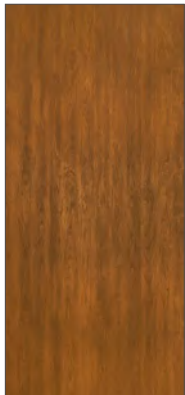

H 6'8" 7'0" 8'0"
W 2'8" 2'10" 3'0" 3'6"

3/4 2-PANEL ARCH TOP

Cherry ★



H 6'8" 7'0" 8'0"
W 2'8" 2'10" 3'0"

3/4 2-PANEL ARCH TOP PLANK

Cherry ★



H 6'8" 7'0" 8'0"
W 2'8" 2'10" 3'0"

2-PANEL SQUARE

Cherry ★



H 8'0"
W 3'6"

2-PANEL SQUARE NARROW PLANK

Cherry



H 8'0"
W 3'6"

2-PANEL SQUARE WIDE PLANK

Cherry



H 8'0"
W 3'6"

3/4 2-PANEL SQUARE

Cherry, Oak ★



H 6'8" 7'0" 8'0"
W 2'8" 2'10" 3'0"

3/4 2-PANEL SQUARE PLANK

Cherry, Oak ★



H 6'8" 7'0"
W 2'8" 2'10" 3'0"

6-PANEL

Cherry, Oak



H 6'8" 7'0"
W 2'10" 3'0"

3-PANEL

Cherry, Mahogany, Oak ★



H 6'8" 7'0"
W 2'8" 2'10" 3'0"

6-PANEL

Cherry, Mahogany, Oak ★



H 6'8" 7'0"
W 2'6" 2'8" 2'10" 3'0"

2-PANEL ARCH TOP

Knotty Alder ★



H 6'8" 7'0" 8'0"
W 2'8" 2'10" 3'0"

2-PANEL ARCH TOP PLANK

Knotty Alder ★



H 6'8" 7'0" 8'0"
W 2'8" 2'10" 3'0"

1-PANEL SHAKER

Fir ★

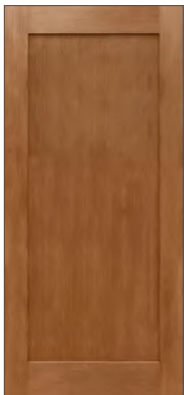

H 6'8" 7'0" 8'0"
W 2'8" 2'10" 3'0"

3-PANEL SHAKER

Fir ★



H 6'8" 7'0" 8'0"
W 2'10" 3'0"

TIMBERGRAIN ACCESSORIES

The Timbergrain Fiberglass Collection offers a variety of accessories that perfectly match each grain texture. Complete any Timbergrain door with matching glass lite frames or simulated divided lites for a refined look.



Shown: 3/4 2-Panel Square in Cherry texture with simulated divided lite bars

CHERRY, OAK, MAHOGANY, AND KNOTTY ALDER GRAIN:



Glass Lite Frames



Simulated Divided Lite Bars

FIR GRAIN:



Glass Lite Frames
(flush fit)



Dentil Shelf (molded
with glass frame)

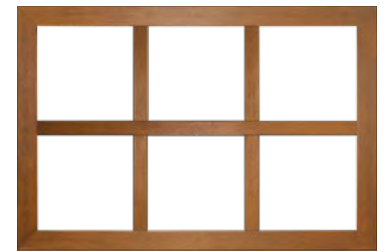

Simulated Divided
Lite Bars



2.25"



3.5"

Mix & Match Wide Simulated Divided Lite Bars
(available in 3.5" or 5.25" wide by 96" long)

*Shown: 3-Panel Craftsman in Fir texture with
dentil shelf and simulated divided lite bars*



TIMBERGRAIN

FIBERGLASS ACCESSORIES



DISCOVER

THE DIFFERENCE

COMPLETE THE SYSTEM

No matter what the project, create a ready-to-install system with our steel-edge doors. Available with a variety of preps, components, and new TaylorKote pre-finish.



32
TAYLORKOTE COMMERCIAL FINISH



33
QUIKFIT FITTED FRAME SYSTEM

BEFORE



AFTER



34
REMODELER SERIES FRAME SYSTEM

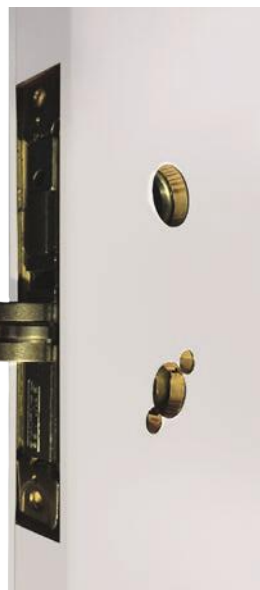

36
CAPABILITIES & PREPS



TAYLORKOTE

COMMERCIAL FINISH

Factory finishing eliminates errors that may occur from finishing in the field, while also providing enhanced durability and a smoother appearance. TaylorKote™ Commercial Finish is ideal for large commercial and multi-family jobs.

FEATURES & BENEFITS

- Available in 8 standard colors on the Cambridge Smooth Steel Collection
- Each color has been formulated to match our Adjustable, Two-Piece QuikFit Frames for a professional, finished look.
- Durable, exterior grade latex paint
- Baked-on curing process for superior paint adhesion
- Factory applied with an innovative, 3-step finishing process that provides consistent coverage
- 25 quantity order minimum

COLOR AVAILABILITY

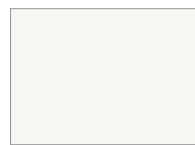

CLASSIC WHITE



DARK BRONZE



CARBON



LIGHT ASH

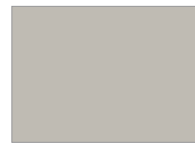

PEBBLE



SLATE



SAND



CLAY BROWN

Custom colors are available by request.

QUIKFIT FITTED FRAME SYSTEM

The QuikFit Door Frame System is an entrance system that features a steel-edge door panel prehung into an adjustable steel frame. This system is easy to install and offers the industry's highest fire and security ratings, making it ideal for a variety of project types.

ADJUSTABLE 2-PIECE FRAME



- Perfect for multi-family and light commercial applications
- Two-piece adjustable steel frame - base jamb is installed in the opening and closer trim piece is attached from the opposite side
- 4-1/2" to 9-1/2" wall construction (1" adjustment) for 1-3/4" door
- Florida Building Code (FBC) and Texas Department of Insurance (TDI) approved
- Design Pressure Ratings of +/- 60 up to 3670
- Available in 6/8, 7/0, and 8/0 heights
- One year warranty

STEEL-EDGE DOOR PANEL

- Prehang any of our steel-edge door panels for a complete 90-minute fire rated door system
- Full steel-edge perimeter provides additional strength and a Grade 40 security rating
- 20+ embossments available in varying heights, widths, and 10" ADA rail
- View our entire offering at taylor-door.com



AVAILABLE COMPONENTS & PREPS

- Four standard hinge preps
- Variety of hinge types & finishes
- Closer & panic reinforcements
- Peep site prep
- Multiple lock prep & bore options
- Retainer & Slide-on sweeps
- Sills: Inswing, Outswing, & ADA Complaint available
- Fire Rating Labels
- Optional snap-on steel casing available in Colonial & Standard profiles

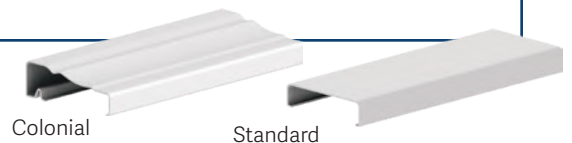

PROFESSIONAL REMODELER FRAME SYSTEM

Bring back new life and energy efficiency to existing openings with our Professional Remodeler Frame System! This system is specially designed to fit over existing wood frames and allows for effortless installation of replacement units. Available to order with a pre-hung steel door for superior durability, efficiency, and security.

- Constructed of 18-gauge galvanized steel for superior corrosion resistance
- Designed to fit over existing wood frames
- Available in:
2/5, 2/7, 2/9, or 2/11 width
6/5, 6/7, 6/9 or 6/11 height
- Frame assembly up to 6/11 height
- 11-gauge hinge reinforcements spot welded for maximum strength
- Prepped with anchoring holes and slots for wood trim
- Special white powder-coated finish requires no sanding or re-coating
- Surpasses the most stringent forced entrance security test
- Weatherstrip and an adjustable threshold provide an energy-saving advantage

EASY INSTALLATION



1 Carefully remove and save interior trim



2 Remove the old door, strike plates, hinges and threshold



3 Insert the replacement unit into the opening from the interior side



4 Nail replacement unit into position



5 Install door hardware



6 Install weatherstripped wood stops and replace interior trim

REMODELER UNDER-SIZE DOOR AVAILABILITY

The Professional Remodeler Frame System can be used with any of our remodeler under-size door styles. Choose from either a smooth or stainable steel door in up to 14 different styles. *Availability varies based off of steel thickness and hinge type.*

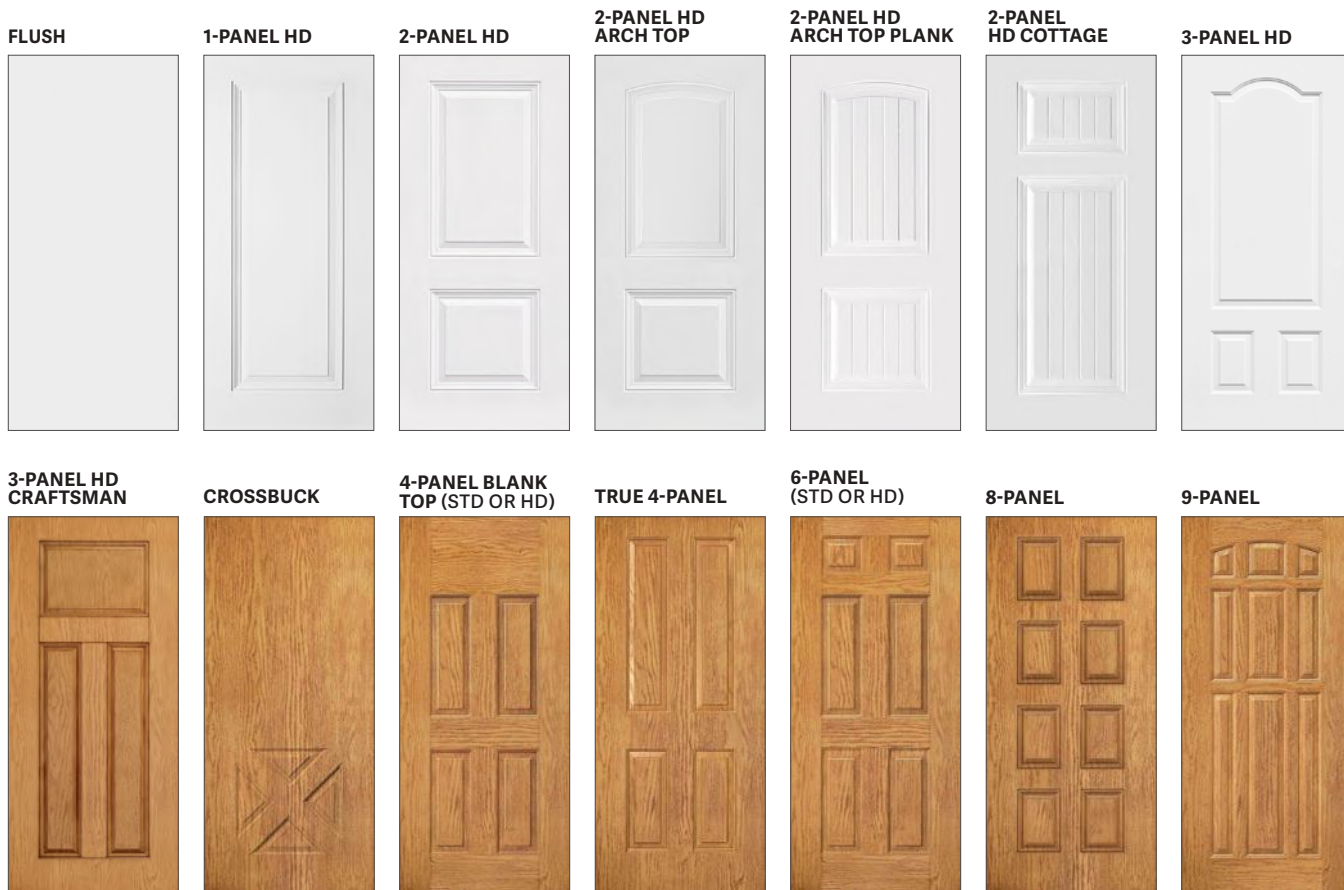



CUSTOM CAPABILITIES

Taylor Entrance Systems™ offers the capability for custom face and edge preps on fiberglass, steel- and wood-edge steel doors. Taylor's one-of-a-kind, state-of-the-art equipment has the capability to do virtually any lock, face bore, or edge prep that a commercial or residential job may require. These custom capabilities are available within the standard 10-day lead time.

GET US THE TEMPLATE, WE'LL MAKE THE DOOR

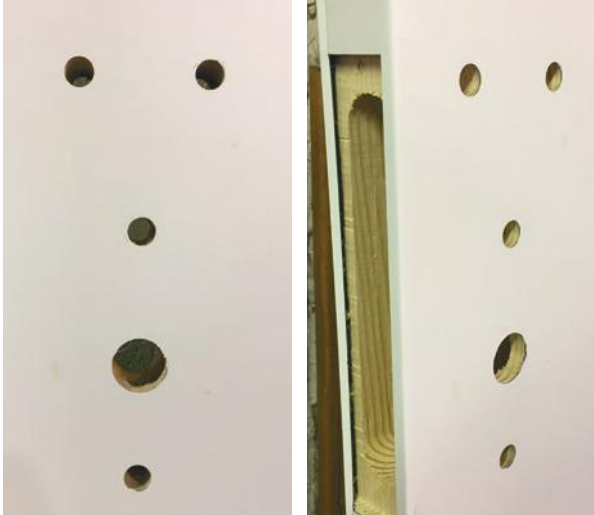
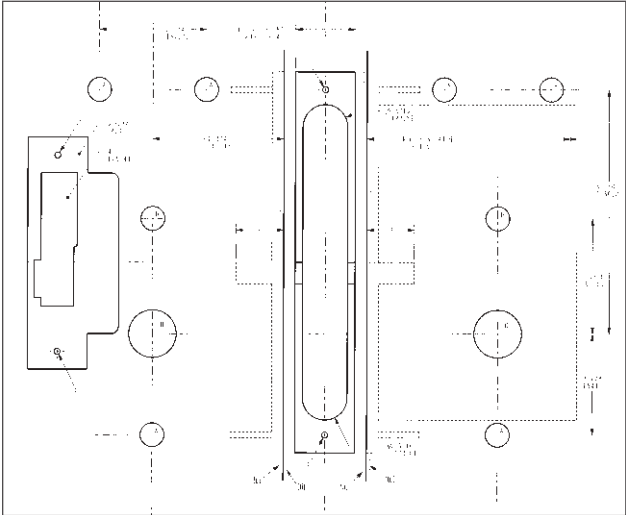

BUILT TO SPEC

Built to Taylor spec, or to any spec you need.

Specs to match competitive brands.

Specs to match hollow metal frames.

Amweld, Republic, Ceco, Curries, Mesker, and more.

Specs to match light gauge metal frames.

IDP, Timley, Rediframe, and more.

SPECIAL HEIGHT & WIDTH

STEEL-EDGE DOOR HEIGHT & WIDTHS

Up to 7'0 height, any width between 23.75" and 41.75"

Over 7'0 height, any width between 23.75" and 35.75"

Minimum height is 76"

Maximum height is 95.25"

HANDING

To hand a door, Face it from the outside or key side

Left Hand Inswing

Hinges on left
Opens inward



Right Hand Inswing

Hinges on right
Opens inward



Left Hand Reverse

Hinges on left
Opens outward



Right Hand Reverse

Hinges on right
Opens outward



CLOSER AND PANIC BAR PREPS



CLOSER
BLOCK



PANIC PREP
& CLOSER
PLATES



HEAD &
FOOT BOLT



MULTI-
PURPOSE
PREP

AVAILABLE HINGE PREPS



STANDARD 4" NON-
TEMPLATE HINGE PREP



STANDARD 4" ADJUSTABLE
NON-TEMPLATE HINGE PREP



4" TEMPLATE
HINGE PREP



4-1/2" COMMERCIAL
TEMPLATE HINGE PREP

ADA SILLS



5" ADA Saddle
fits 4.5" - 5.5" wall thickness



6" ADA Saddle
fits 5.5" - 6.5" wall thickness



7" ADA Saddle
fits 6.5" - 7.5" wall thickness



8" ADA Saddle
fits 7.5" - 8.5" wall thickness



TECHNICAL TOOLS

From technical data to installation instructions, Taylor Entrance Systems™ has the tools you will need to specify exterior doors for your light commercial projects.

- Download high quality design files from Arcat.com for our steel and fiberglass entrance door systems.
- View products approved by HVHZ in our website's Technical Library, or from the Florida Building Code website
- Our website's Technical Library contains fire ratings, STC and OITC ratings, along with Impact and Design Pressure information.
- Our products meet the requirements for ENERGY STAR, coastal codes and industry security tests.

taylordoor.com

SOUND TRANSMISSION CLASS (STC) RATING

Product	Rating
22-gauge steel-edge Steel Door	STC 25
24-gauge steel-edge Steel Door	STC 22
Edgewood® Steel Door	STC 24
Timbergrain Fiberglass Door	STC 25



For additional technical information, CAD drawings, and specifications, visit our page on ARCAT.com

FIRE RATINGS

Product	Rating
Cambridge Smooth Steel Collection	20 or 90 minute
West Guard 20-Gauge Steel Collection	20 or 90 minute
Trugrain™ Steel Collection	20 or 90 minute
Norwood Stainable Steel Collection	20 or 90 minute
TruKote Steel Collection	20 or 90 minute
Edgewood® Wood-Edge Steel Collection	20 minute
Grand Marais Fiberglass Collection	20 minute (select styles)
Timbergrain Fiberglass Collection	not rated



FIRE GLASS

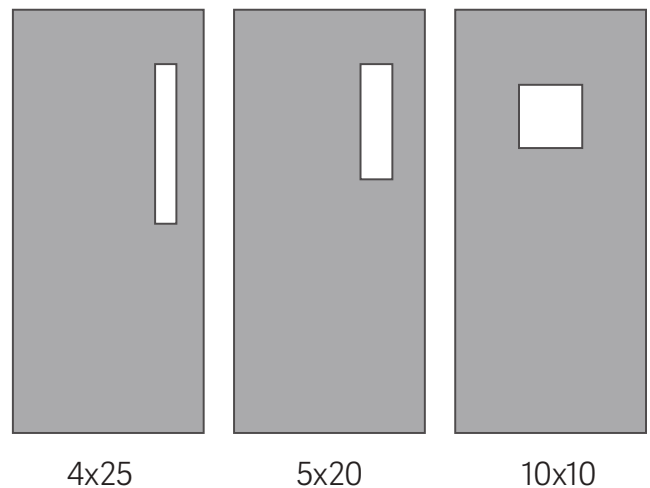

NOTE: Other styles available by request.

TEXAS HURRICANE & WINDLOAD APPROVALS

Texas Department of Insurance (TDI) approvals

Product	Description	TDI Approval Numbers
Impact	6/8 and 8/0 Glazed Steel Entry Doors, Inswing and Outswing, Singles and Doubles, with and without Sidelights	DR-737, TX4504, TX4505, TX4506, TX4507
Impact	7/0 Opaque Steel Entry Doors with IDP Adjustable Steel Door Frame, Inswing and Outswing, Singles	DR-740, TX4503
Impact	7/0 Opaque Steel Entry Doors with Dunbarton Adjustable Steel Door Frame, Inswing and Outswing	DR-964, TX4784
Impact	6/8 Opaque Wood Edge Steel Side Hinge Doors, Outswing and Inswing, Singles	DR-993, TX4862
Non-Impact	6/8 and 8/0 Glazed Steel Entry Doors, Inswing and Outswing, Singles and Doubles, with and without Sidelights	DR-734, TX4496, TX4497, TX4498, TX4495
Non-Impact	6/8 and 8/0 Opaque Steel Entry Doors, Inswing and Outswing, Singles and Doubles, with and without Sidelights	DR-739, TX4499, TX4500, TX4501, TX4502
Timbergrain Impact	6/8 and 8/0 Single Opaque Fiberglass Entry Doors, Inswing and Outswing	DR-606, TX4512, TX4513
Timbergrain Non-Impact	6/8 and 8/0 Glazed Fiberglass Entry Doors, Inswing, Singles & Doubles, with and without Sidelights	DR-619, TX4518, TX4259, TX4260, TX4261

HURRICANE & WINDLOAD APPROVALS

Taylor Entrance Systems™ has numerous options available to meet your Hurricane and Windload requirements. We manufacture products that are approved for sale in both the HVHZ (High Velocity Hurricane Zone) and non-HVHZ areas of Florida. A more detailed summary of the approvals are available from our website's Technical Library.

The full approvals and details can be downloaded from the Florida Building Code (FBC) website at floridabuilding.org. To access these documents, search under the product approval section.

Florida Approval Number	Model, Number, or Name	Description	Approved for use in HVHZ	Approved for use outside HVHZ	Impact Resistant
FL-8845.1	Steel Edge Door - Glazed	Outswing or Inswing Insulated "Impact" Glazed Steel Edge Door - Single (X) Configuration up to 6/8 in Height	X	X	X
FL-8845.2	Steel Edge Door - Glazed	Outswing or Inswing Insulated "Impact" Glazed Steel Edge Door - Single with Sidelite (XO or OX) Configuration up to 6/8 in Height	X	X	X
FL-8845.3	Steel Edge Door - Glazed	Outswing or Inswing Insulated "Impact" Glazed Steel Edge Door - Single with Sidelites (OXO) Configuration up to 6/8 in Height	X	X	X
FL-8845.4	Steel Edge Door - Glazed	Outswing or Inswing Insulated "Impact" Glazed Steel Edge Door - Double (XX) Configuration up to 6/8 in Height	X	X	X
FL-8845.5	Steel Edge Door - Glazed	Outswing or Inswing Insulated "Impact" Glazed Steel Edge Door - Double with Sidelites (OXXO) Configuration up to 6/8 in Height	X	X	X
FL-8845.6	Steel Edge Door - Glazed	Outswing or Inswing Insulated "Impact" Glazed Steel Edge Door - Single (X) Configuration up to 8/0 in Height	X	X	X
FL-8845.7	Steel Edge Door - Glazed	Outswing or Inswing Insulated "Impact" Glazed Steel Edge Door - Single with Sidelite (XO or OX) Configuration up to 8/0 in Height	X	X	X
FL-8845.8	Steel Edge Door - Glazed	Outswing or Inswing Insulated "Impact" Glazed Steel Edge Door - Single with Sidelites (OXO) Configuration up to 8/0 in Height	X	X	X
FL-8845.9	Steel Edge Door - Glazed	Outswing or Inswing Insulated "Impact" Glazed Steel Edge Door - Double (XX) Configuration up to 8/0 in Height	X	X	X
FL-8845.10	Steel Edge Door - Glazed	Outswing or Inswing Insulated "Impact" Glazed Steel Edge Door - Double with Sidelites (OXXO) Configuration up to 8/0 in Height	X	X	X
FL-8845.11	Steel Edge Door - Opaque	Outswing or Inswing Insulated "Impact" Opaque Steel Edge Door - Single (X) Configuration up to 6/8 in Height	X	X	X
FL-8845.12	Steel Edge Door - Opaque	Outswing or Inswing Insulated "Impact" Opaque Steel Edge Door - Single with Sidelite (XO or OX) Configuration up to 6/8 in Height	X	X	X
FL-8845.13	Steel Edge Door - Opaque	Outswing or Inswing Insulated "Impact" Opaque Steel Edge Door - Single with Sidelites (OXO) Configuration up to 6/8 in Height	X	X	X
FL-8845.14	Steel Edge Door - Opaque	Outswing or Inswing Insulated "Impact" Opaque Steel Edge Door - Double (XX) Configuration up to 6/8 in Height	X	X	X
FL-8845.15	Steel Edge Door - Opaque	Outswing or Inswing Insulated "Impact" Opaque Steel Edge Door - Double with Sidelites (OXXO) Configuration up to 6/8 in Height	X	X	X
FL-8845.16	Steel Edge Door - Opaque	Outswing or Inswing Insulated "Impact" Opaque Steel Edge Door - Single (X) Configuration up to 8/0 in Height	X	X	X
FL-8845.17	Steel Edge Door - Opaque	Outswing or Inswing Insulated "Impact" Opaque Steel Edge Door - Single with Sidelite (XO or OX) Configuration up to 8/0 in Height	X	X	X
FL-8845.18	Steel Edge Door - Opaque	Outswing or Inswing Insulated "Impact" Opaque Steel Edge Door - Single with Sidelites (OXO) Configuration up to 8/0 in Height	X	X	X
FL-8845.19	Steel Edge Door - Opaque	Outswing or Inswing Insulated "Impact" Opaque Steel Edge Door - Double (XX) Configuration up to 8/0 in Height	X	X	X
FL-8845.20	Steel Edge Door - Opaque	Outswing or Inswing Insulated "Impact" Opaque Steel Edge Door - Double with Sidelites (OXXO) Configuration up to 8'0 in Height	X	X	X
FL-9542.1	Steel Edge Door - Glazed	6/8 "Non-Impact" Glazed Steel Edge Single Insulated Steel Door - Outswing / Inswing (X) Configuration		X	
FL-9542.2	Steel Edge Door - Glazed	6/8 "Non-Impact" Glazed Steel Edge Single Insulated Steel Door with or without "Non-Impact" Sidelite or Sidelites - Outswing / Inswing (OX or XO; OXO) Configurations		X	
FL-9542.3	Steel Edge Door - Glazed	6/8 "Non-Impact" Glazed Steel Edge Double Insulated Steel Door with or without "Non-Impact" Sidelites - Outswing / Inswing (XX; OXXO) Configurations		X	
FL-9542.4	Steel Edge Door - Glazed	8/0 "Non-Impact" Glazed Steel Edge Single Insulated Steel Door - Outswing / Inswing (X) Configuration		X	

Florida Approval Number	Model, Number, or Name	Description	Approved for use in HVHZ	Approved for use outside HVHZ	Impact Resistant
FL-9542.5	Steel Edge Door - Glazed	8/0 "Non-Impact" Glazed Steel Edge Single Insulated Steel Door with or without "Non-Impact" Sidelite or Sidelites - Outswing / Inswing (OX or XO; OXO) Configurations		X	
FL-9542.6	Steel Edge Door - Glazed	8/0 "Non-Impact" Glazed Steel Edge Double Insulated Steel Door with or without "Non-Impact" Sidelites - Outswing / Inswing (XX; OXXO) Configurations		X	
FL-14513.1	Steel Edge Door - Opaque	Up to a Nominal 3/6 x 7/0 Opaque Steel Edge Steel Door in a Two Piece Steel Frame System (K2A Series Steel frame). Inswing / Outswing Configuration (X)	X	X	X
FL-14513.2	Steel Edge Door - Opaque	Up to a Nominal 3/6 x 7/0 Opaque Steel Edge Steel Door in a Fixed Steel Frame System (F Series Steel frame). Inswing / Outswing Configuration (X)	X	X	X
FL-14513.3	Steel Edge Door - Opaque	Up to a Nominal 3/6 x 7/0 Opaque Steel Edge Steel Door in a Two Piece Steel Frame System (Rediflex Steel frame). Inswing / Outswing Configuration (X)		X	X
FL-15135.1	Wood Edge Door - Glazed	Insulated Glazed Wood Edge Steel Door - Single (X) Outswing/Inswing Configurations up to 6/8 in Height		X	
FL-15135.2	Wood Edge Door - Glazed	Insulated Glazed Wood Edge Steel Door - Single with or without Sidelites (OX or XO, OXO) Outswing/Inswing Configurations up to 6/8 in Height		X	
FL-15135.3	Wood Edge Door - Glazed	Insulated Glazed Wood Edge Steel Door - Double with or without Sidelites (XX, OXXO) Outswing/Inswing Configurations up to 6/8 in Height		X	
FL-15135.4	Wood Edge Door - Glazed	Insulated "Impact" Glazed Wood Edge Steel Door - Single (X) Outswing/Inswing Configurations up to 6/8 in Height		X	X
FL-15135.5	Wood Edge Door - Glazed	Insulated "Impact" Glazed Wood Edge Steel Door - Single with or without Sidelites (OX or XO, OXO) Outswing/Inswing Configurations up to 6/8 in Height		X	X
FL-15135.6	Wood Edge Door - Glazed	Insulated "Impact" Glazed Wood Edge Steel Door - Double with or without Sidelites (XX, OXXO) Outswing/Inswing Configurations up to 6/8 in Height		X	X
FL-15135.7	Wood Edge Door - Glazed	Insulated "Impact" Opaque Wood Edge Steel Door - Single (X) Outswing/Inswing Configurations up to 6/8 in Height		X	X
FL-15135.8	Wood Edge Door - Glazed	Insulated "Impact" Opaque Wood Edge Steel Door - Single with or without Sidelites (OX or XO, OXO) Outswing/Inswing Configurations up to 6/8 in Height (Utilizes Taylor "Impact" Sidelites)		X	X
FL-15135.9	Wood Edge Door - Glazed	Insulated "Impact" Opaque Wood Edge Steel Door - Double with or without Sidelites (XX, OXXO) Outswing/Inswing Configurations up to 6/8 in Height (Utilizes Taylor "Impact" Sidelites)		X	X
FL-15135.10	Wood Edge Door - Glazed	Insulated "Impact" Opaque Wood Edge Steel Door - Single with or without Sidelites (OX or XO, OXO) Outswing/Inswing Configurations up to 6/8 in Height (Utilizes ODL "Impact" Sidelites)		X	X
FL-15135.11	Wood Edge Door - Glazed	Insulated "Impact" Opaque Wood Edge Steel Door - Double with Sidelites (OXXO) Outswing/Inswing Configurations up to 6/8 in Height (Utilizes ODL "Impact" Sidelites)		X	X
FL-15135.12	Wood Edge Door - Glazed	Insulated "Impact" Opaque Wood Edge Steel Door - Single (X) Outswing/Inswing Configurations up to 8/0 in Height		X	X
FL-15135.13	Wood Edge Door - Glazed	Insulated "Impact" Opaque Wood Edge Steel Door - Single with or without Sidelites (OX or XO, OXO) Outswing/Inswing Configurations up to 8/0 in Height (Utilizes Taylor "Impact" Sidelites)		X	X
FL-15135.14	Wood Edge Door - Glazed	Insulated "Impact" Opaque Wood Edge Steel Door - Double with or without Sidelites (XX, OXXO) Outswing/Inswing Configurations up to 8/0 in Height (Utilizes Taylor "Impact" Sidelites)		X	X
FL-15135.15	Wood Edge Door - Glazed	Insulated "Impact" Opaque Wood Edge Steel Door - Single with or without Sidelites (OX or XO, OXO) Outswing/Inswing Configurations up to 8/0 in Height (Utilizes ODL "Impact" Sidelites)		X	X
FL-15135.16	Wood Edge Door - Glazed	Insulated "Impact" Opaque Wood Edge Steel Door - Double with Sidelites (OXXO) Outswing/Inswing Configurations up to 8/0 in Height (Utilizes ODL "Impact" Sidelites)		X	X
FL-15931.1	Timbergrain	Up to a 3/0 x 6/8 Opaque Fiberglass Door (X Configuration) Inswing/Outswing		X	X
FL-15931.2	Timbergrain	Up to a 3/0 x 6/8 Opaque Fiberglass Door with Non-impact Fiberglass Sidelite or Sidelites - Insulated Glass (XO or OX, OXO Configurations) Inswing or Outswing		X	
FL-15931.3	Timbergrain	Up to a 6/0 x 6/8 Opaque Fiberglass Door with or without Non-impact Fiberglass Sidelites - Insulated Glass (XX or OXXO Configurations) Inswing or Outswing		X	
FL-15931.4	Timbergrain	Up to a 3/0 x 6/8 Non-impact Glazed Fiberglass Door with Non-impact Glazed Fiberglass Sidelite or Sidelites - Insulated Glass (X, XO or OX, OXO Configurations) Inswing or Outswing		X	
FL-15931.5	Timbergrain	Up to a 6/0 x 6/8 Non-impact Glazed Fiberglass Door with or without Non-impact Fiberglass Sidelites - Insulated Glass (XX or OXXO Configurations) Inswing or Outswing		X	
FL-15931.6	Timbergrain	Up to a 3/0 x 8/0 Opaque Fiberglass Door (X Configuration) Inswing/Outswing		X	X
FL-15931.7	Timbergrain	Up to a 3/0 x 8/0 Opaque Fiberglass Door with Non-impact Fiberglass Sidelite or Sidelites - Insulated Glass (XO or OX, OXO Configurations) Inswing or Outswing		X	
FL-15931.8	Timbergrain	Up to a 6/0 x 8/0 Opaque Fiberglass Door with or without Non-impact Fiberglass Sidelites - Insulated Glass (XX or OXXO Configurations) Inswing or Outswing		X	
FL-15931.9	Timbergrain	Up to a 3/0 x 8/0 Non-impact Glazed Fiberglass Door with Non-impact Glazed Fiberglass Sidelite or Sidelites - Insulated Glass (X, XO or OX, OXO Configurations) Inswing or Outswing		X	
FL-15931.10	Timbergrain	Up to a 6/0 x 8/0 Non-impact Glazed Fiberglass Door with or without Non-impact Fiberglass Sidelites - Insulated Glass (XX or OXXO Configurations) Inswing or Outswing		X	

NOTE: Please visit the Florida Building Code website for full details of approvals.



70+ YEARS OF INNOVATION

UNMATCHED LEAD TIMES

We are committed to shipping stock doors within 10 working days or less.

ADDITIONAL AVAILABILITY

Additional sizes and styles may be available with extended lead times.

NO MINIMUMS OR MAXIMUMS

With no order requirements, you can get what you need, when you need it.



MICHIGAN MADE

Passion, hard work and respect – it's the culture of our workplace. We meticulously test for quality every day to ensure that you are receiving the best product we can produce. When you choose Taylor, you are choosing quality. Our products are built with pride and confidence, giving you the satisfaction of buying a high-quality, American made, reliable product.

HARD WORK + DEDICATION

We've established a management philosophy in which teamwork plays an important role. Our employees work together to manufacture quality entrance systems while our customers work closely with professionals to meet the demands of the end user.

PRODUCT INNOVATION

An unwavering commitment to beauty, quality, and value has allowed Taylor Entrance Systems™ to develop a long history of innovation, bringing numerous products to the market that have helped to further shape the fenestration industry.

We are dedicated to providing innovative solutions and value-added products to fill the needs in an ever-changing marketplace.

PARTNERSHIP

At Taylor Entrance Systems™, we credit our success to our dedicated employees, the quality of our products and the integrity of our customers. Building meaningful relationships in all aspects of our business is a priority.

Contact our exceptional Customer Service department for order inquiries.

Phone: 800.248.3600

Fax: 800.252.5468

Request a Quote: quotes@taylordoor.com

Place an Order: orders@taylordoor.com

Beauty, quality,
and value are on
display in every
product we make.



TAYLOR ENTRANCE SYSTEMS™
631 North First Street
West Branch, Michigan 48661

sales@taylordoor.com
office: 800.248.3600
fax: 800.252.5468